

Operating and Assembly Instructions

Door Intercom System

DoorLine Slim DECT

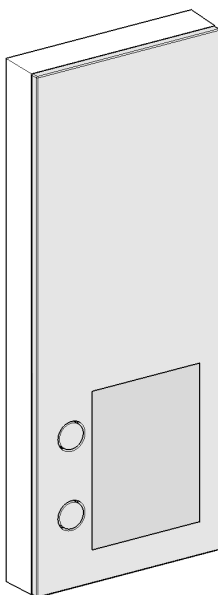

Telegärtner
Elektronik GmbH

1 Preface

Congratulations for purchasing the DoorLine Slim DECT from Telegärtner.

Read through these Operating Instructions carefully and attentively. They contain important information for your safety and valuable tips and additional application options of the device. The information on usage and care should guarantee that you have many years of satisfaction with our product. Please retain all documents, also for subsequent owners.

The content of these Operating Instructions has been prepared with great care. In spite of all checks, however, there is still a possibility that technical inaccuracies and typographical errors have been overlooked. All errors that come to our notice shall be eliminated in new editions. We highly appreciate your feedback at any time if you find a mistake that we overlooked.

These Operating Instructions also use the term "device" to refer to the DoorLine Slim DECT.

The private branch exchange system is also referred to as "PBX System". The private branch exchange system is possibly a function of your router (Fritz!Box, Speedport, etc.) or your base station.

1.1 Copyright

Copyright 2020 Telegärtner Elektronik GmbH
Hofäckerstraße 18
74564 Crailsheim

We reserve all rights to this documentation, particularly in the case of patent or utility model applications. The documentation, or parts thereof, must not be altered manually, or in any other manner, without the express written authorization from us, nor translated into any other language or computer language of any form and by any means. This applies to electronic, mechanical, optical, chemical and all other media. Product designations and company names used in this documentation are subject to the rights of the companies in question.



Table of contents

1	Preface	2
1.1	Copyright	2
2	Safety instructions	6
3	Product information and description	7
3.1	Model variants	8
3.2	Nameplate	8
3.3	Specified use	9
3.3.1	Notes on the use of an electronic door opener	9
3.4	Technical prerequisites	10
3.5	Technical data	10
3.6	Accessories	11
4	Assembly and connection	12
4.1	For your safety	12
4.2	Scope of supply	12
4.3	Prior to assembly	13
4.4	Place of installation	13
4.5	Installing device	13
4.5.1	Installing mounting plate on the wall	14
4.5.2	Installing device on mounting plate	15
4.6	Connecting device	16
4.6.1	Important notes	16
4.6.2	Wiring	17
4.6.3	Terminal assignment	18
4.6.4	Wiring diagram	19
4.6.5	Connection example for a door opener and a door bell	20
4.6.6	DoorLine registration	21
4.6.7	Checking connection	22
4.6.8	Check of DECT signal strength	22
4.7	Labelling bell pushbuttons	23
5	Configuration	25
5.1	Factory settings	25
5.2	Restoring factory settings	25
5.3	Acknowledgement tones	26
5.4	Saving and ending configuration	26
5.5	Entry to configuration mode	26
5.6	Defining microphone sensitivity and volume	27

5.7	Change the PIN Code	28
5.8	Call numbers for bell pushbuttons.....	29
5.8.1	Defining call numbers for bell pushbuttons.....	29
5.8.2	Deleting call numbers.....	30
5.9	Enabling door opener function	31
5.10	Defining door opener time	31
5.11	Defining call duration.....	33
5.12	Defining call duration to extension line	34
5.13	Call mode	34
5.13.1	Mute connection setup with call reception by button redial	34
5.13.2	Connection setup with tone output	35
5.13.3	Mute connection setup.....	35
5.14	Defining absence numbers	36
5.14.1	Defining call numbers for call forwarding	36
5.14.2	Deleting call numbers for call forwarding.....	37
5.15	Configuring relay contacts	37
5.15.1	Configuration of relay contact 1	38
5.15.2	Configuration of relay contact 2	39
6	Configuration of SwitchBox.....	40
6.1	Registering SwitchBox.....	40
6.2	Defining PIN Code for SwitchBox.....	40
6.3	Configuring SwitchBox relay contacts	41
6.3.1	Configuring SwitchBox relay contact 1	42
6.3.2	Configuring SwitchBox relay contact 2.....	43
6.3.3	Configuring SwitchBox relay contact 3.....	44
7	Overview of programming table.....	45
8	Everyday use	48
8.1	Receiving a door call	48
8.2	Opening a door.....	49
8.3	Calling the DoorLine.....	50
8.4	Activating / deactivating call forwarding to absence number	51
8.5	Direct commands during voice communication	53
9	Malfunctions and fault elimination.....	54



10 Maintenance, care and disposal.....	55
10.1 Cleaning.....	55
10.2 Storage.....	55
10.3 Disassembly.....	55
10.4 Disposal.....	55
10.4.1 Disposing of packaging material.....	55
10.4.2 Disposing of old device.....	55

2 Safety instructions

Before installing or using the product, it is essential to observe the instructions in this manual.

If you fail to follow these instructions, the manufacturer Telegärtner Elektronik GmbH will not accept any liability for any damage resulting from negligent or deliberate disregard of the instructions in this operating manual!

- Keep small parts and packaging well away from children. There is a danger of suffocation.
- Connect the product only to equipment that supplies SELV (Safety Extra Low Voltage).
- Only connect CE-certified end devices to the telephone system.
- Do not connect devices that have equipotential bonding including earthing on the lines.
- Do not use damaged devices. Have a damaged device repaired immediately.
- The lines must not be installed or connected during storms. Nor is it permitted to insert or unplug the connection plug during storms.
- The housing must not be opened under any circumstances. Unauthorised opening, incorrect repairs or modification can result in dangers to the user. Warranty claims shall also be rendered void.
- Protect the product against dust, aggressive liquids and vapours.
- Do not use the product in damp rooms or in potentially explosive areas.
- Do not install your product near heat sources or other electrical devices.
- Do not permit liquid to penetrate the interior of the product. This may result in electric shock or short-circuits.
- Route connecting lines and cables such that there is no risk of accidents!
- The DoorLine Slim DECT contains a radio module based on the DECT standard. The operation of medical devices may be impaired. Note the technical conditions of the respective environment, e.g. medical practice.

3 Product information and description

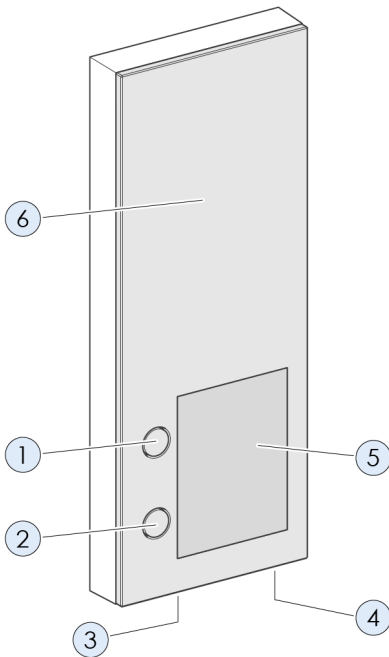

Item	Description
1	Bell pushbutton 1 (capacitance)
2	Bell pushbutton 2 (capacitance)
3	Brightness sensor
4	Microphone
5	Labelling panel
6	Loudspeaker (not visible)

3.1 Model variants

DoorLine Slim DECT

Surface	Glass	
Colour/Article number	white	150720
	black	150730

3.2 Nameplate

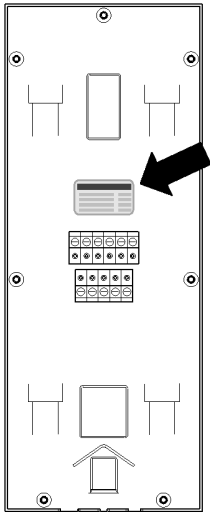

The nameplate contains the serial number, product coding and information on the device type.

3.3 Specified use

The DoorLine is designed for connection to DECT-compatible PBX systems.

It can be used

- as an intercom
- for remote-controlled opening of doors or gates
- for relaying door conversations to telephones
- for connection to other control systems

DoorLine has been developed for private as well as commercial use.

3.3.1 Notes on the use of an electronic door opener

There is an increased risk of burglary if you connect a door opener if the relay contacts are accessible following disassembly of the DoorLine.

It is safer to configure a door opener via a SwitchBox (accessories) because this is located inside the house, which means that the relay contacts cannot be manipulated from the outside.

An electric door opener does not substitute door closure by a locking bar, it is an intelligent, additional safety feature.

It is primarily intended for daytime operation, whereas at night time or in case of absence the relevant door is locked by the locking bar.

As far as insurance is concerned, a door that is held closed only by the use of the door opener is not regarded as locked!

3.4 Technical prerequisites

- The DoorLine is designed for connection to DECT-compatible PBX systems.
- Both relay switching outputs of the device connect potential-free. This means that when a door opener or a similar device is activated, it may be necessary to provide an additional bell transformer (see chapter Connecting device ▶ 16]).
- Your PBX system and end devices (telephones) must support touch-tone dialling (DTMF).
- The DoorLine is not suitable for complete surface mounting. We recommend assembly on a standard in-wall socket.

3.5 Technical data

Connection to the base	Radio standard frequency range	DECT / GAP-compatible 1881 - 1897 MHz
	Range inside the building	up to 40 m
	Range outdoors	up to 300 m
Bell pushbuttons	Number	2
Call numbers	Number	per button 2 call numbers with max. 20 positions
Relay switching outputs	Relay switching output 1	potential-free, 24 V AC / DC 1 A
	Relay switching output 2	potential-free, 24 V AC / DC 1 A
General data	Power supply	12 V / 12 W, controlled
	Cable length for power supply	max. 10 m
	Current consumption	Standby 1 W Call state max. 3.5 W
	Degree of protection	IP54 (in installed state)
	Operating temperature	-20 °C to +60 °C
	Weight	500 g
Dimensions	Mounting plate	176x79 mm
	Device	220x85x21 mm

3.6 Accessories

- Wall power supply SNG DL article number 105248
(For use as bell transformer, door opener current supply, etc. Cannot be used for power supply to the DoorLine Slim DECT!)
- Power unit for carrier rail assembly (DIN rail), article number 114651
(For power supply to the DoorLine Slim DECT)
- SwitchBox SB-442 article number 151003
Surface mounting or assembly on carrier rail (DIN rail)
 - 4 PBX system connectable
(only in conjunction with DoorLine Slim and DoorLine Pro Exclusive)
 - Extends the DoorLine Slim DECT by three further relay contacts

4 Assembly and connection

4.1 For your safety

Assembly must only be carried out by specialists with corresponding skills and experience. These persons must be able to detect dangers and to avoid possible risks.

The statutory specifications at the place of installation must be observed.

Take care not to jam the connecting cables during installation.

Also observe the safety instructions at the start of the Operating Instructions.

Caution: The front panel of the device is made of glass. It can be damaged and cause injury. Protect the glass surfaces against damage.

4.2 Scope of supply

The scope of supply of the device includes:

- the device
- Assembly and Operating Instructions
- mounting plate
- sealing flange
- bag with fastening material and Allen key
- wall power supply

4.3 Prior to assembly

Check all parts for completeness and transport damage prior to assembly.

We recommend that you initially register the DoorLine in the direct vicinity of your PBX system, try it out and make the basic configuration.

In this manner, you can install the wiring and configure the bell pushbutton quickly and easily.

After the DoorLine functions perfectly in this test setup with your TC system and telephones, you can install the DoorLine in its final place of usage.

4.4 Place of installation

- The device is intended for installation outdoors in an area protected from splash water (moisture protection as per IP 54, splash water at an angle of up to 60° to the verticals).
- A minimum distance from the microphone to the nearest corner wall surface of at least 10 cm must be observed.
- The ambient temperature must be between -20 °C and +60 °C.
- In the area of the installation location, no supply lines or similar must be installed.

4.5 Installing device

The device is installed on a standard in-wall socket or a corresponding cavity by means of the enclosed mounting plate and fastening material.

The device can be sealed at the top and the side with sealants such as silicone or acryl.

Caution: Incorrect sealing can result in the formation of moisture. This can cause damage to the device. Do not seal the device at the bottom.

4.5.1 Installing mounting plate on the wall

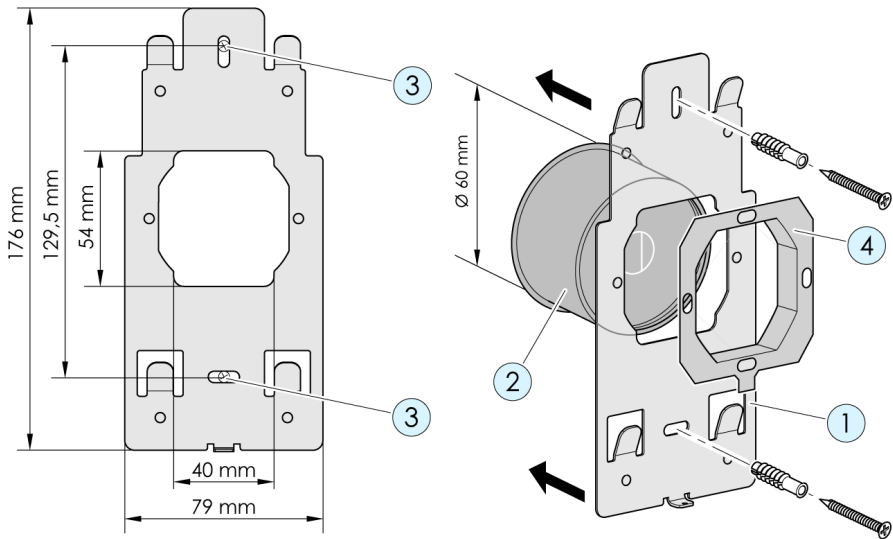

1. Position the mounting plate **(1)** on a standard in-wall socket **(2)** or a suitable cavity in the masonry. The recess in the mounting plate must be fitted accurately on the in-wall socket.
2. Ensure that no supply lines, cables or similar are installed in the area of the drilling holes **(3)**.
3. Fasten the mounting plate via the two boreholes **(3)** onto the wall with screws and dowels.
4. Press the sealing flange **(4)** into the recess on the mounting plate **(1)**.

4.5.2 Installing device on mounting plate

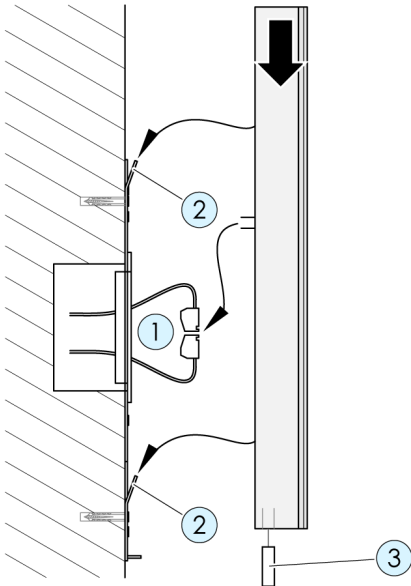

1. Connect the terminals (1) (see chapter Connecting device [▶ 16]).
2. Insert the terminals (1) back into the device.
3. Place the device diagonally from above onto the mounting plate until the four metal lugs (2) engage in the four fastening holes of the device.
4. Secure the device with the hexagon socket-grub screw (3) on the mounting plate.

Caution: Only tighten the screw lightly because otherwise the thread can be damaged.

4.6 Connecting device

4.6.1 Important notes

- Before connecting the device to the PBX system, switch off all required components and those connected to the DoorLine (bell transformer, power unit).
- When installing the wiring, ensure that the polarity (12 V DC voltage) of the two wires in the terminals is correct.
- Do not insert the wall power supply into the socket until all wires are firmly connected and there is no risk of a short circuit of wire pairs.
- A bell transformer (e.g. 12 V alternating voltage) must not be used as a power supply for the device. This can result in destruction of the device!
- Both integrated relay contacts connect potential-free, i.e. an additional bell transformer is required to activate a door opener. Then connect the bell transformer voltage via the respective relay switching output to the door opener (see chapter Connection example for a door opener and a door bell [► 20]).
- Both switching relays can be loaded to a max. of 24 V AC / DC 1 A. Prior to initial operation of the device, ensure that these values are not exceeded by your door opener, door bell or other devices to be connected. Observe the Operating Instructions of the respective products.

4.6.2 Wiring

For the installation wiring of the relay contacts, SwitchBox and power supply of the device, use commercially available telecommunication cables.

Please note that in order to meet general safety provision and to avoid interference influences, the low-current lines must be routed separately from power lines.

Observe a minimum distance of 10 cm between both types of lines. If one of the connected lines is routed out-of-doors, you will have to provide sufficient lightning protection.

Lines types that can be used

- Telecommunication indoor cable
 - J-Y(ST)-Y 2 x 2 x 0.6
 - J-Y(ST)-Y 2 x 2 x 0.8
 - J-Y(ST)-Y 4 x 2 x 0.6
 - J-Y(ST)-Y 4 x 2 x 0.8
- Bell sheathed cable
 - YR 4 x 0.8
- Telecommunications cable
 - A-2Y(L)2Y 4 x 2 x 0.8

Maximum cable lengths for connection to door opener

Wire diameter		0.8 mm	0.6 mm
Ranges for door opener operation from an external bell transformer to door opener (maximum current consumption 1A alternating voltage)	12 V	38 m	17 m
	16 V	76 m	34 m
	20 V	115 m	51 m
	24 V	177 m	78 m

4.6.3 Terminal assignment

The rear side of the device has two screw-in/terminal plug-in connectors. They can be unplugged for convenient connection of the lines.

Labelling is on the rear side of the housing.

View from the rear

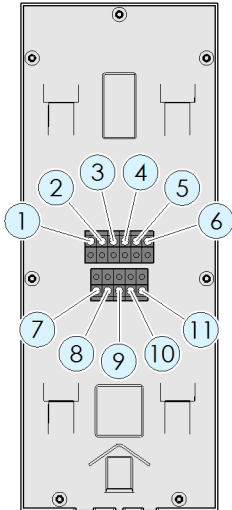

View of terminals

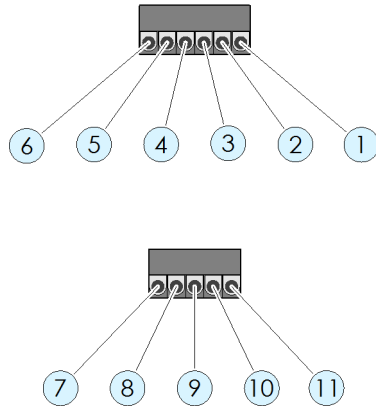

1 Supply voltage +12 V

2 Supply voltage GND

3 Relay contact 2
potential-free

4 Relay contact 2
potential-free

5 Relay contact 1
potential-free

6 Relay contact 1
potential-free

7 SwitchBox data

8 SwitchBox -

9 SwitchBox +

10 not assigned

11 not assigned

4.6.4 Wiring diagram

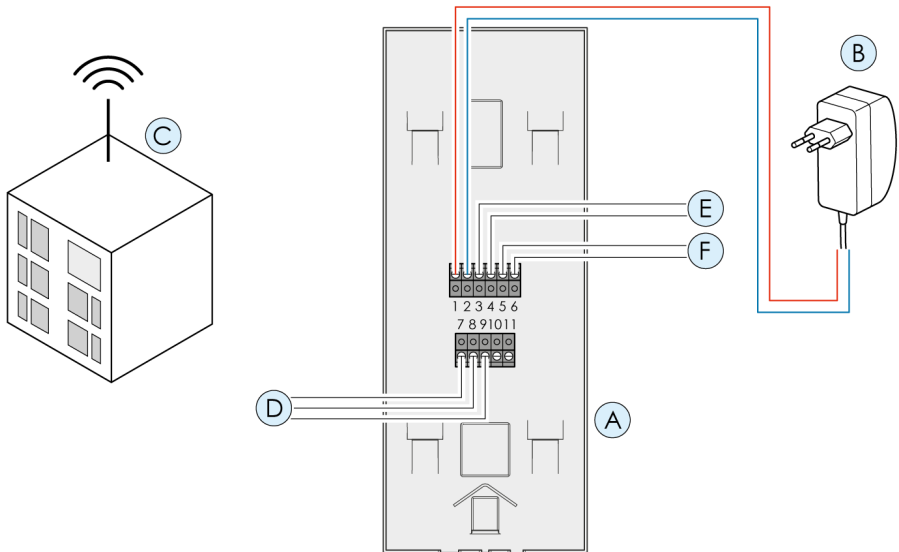

Item	Description
A	DoorLine (rear side)
B	Wall power supply
C	DECT-compatible PBX system
D	SwitchBox
E	Relay contact 2
F	Relay contact 1

4.6.5 Connection example for a door opener and a door bell

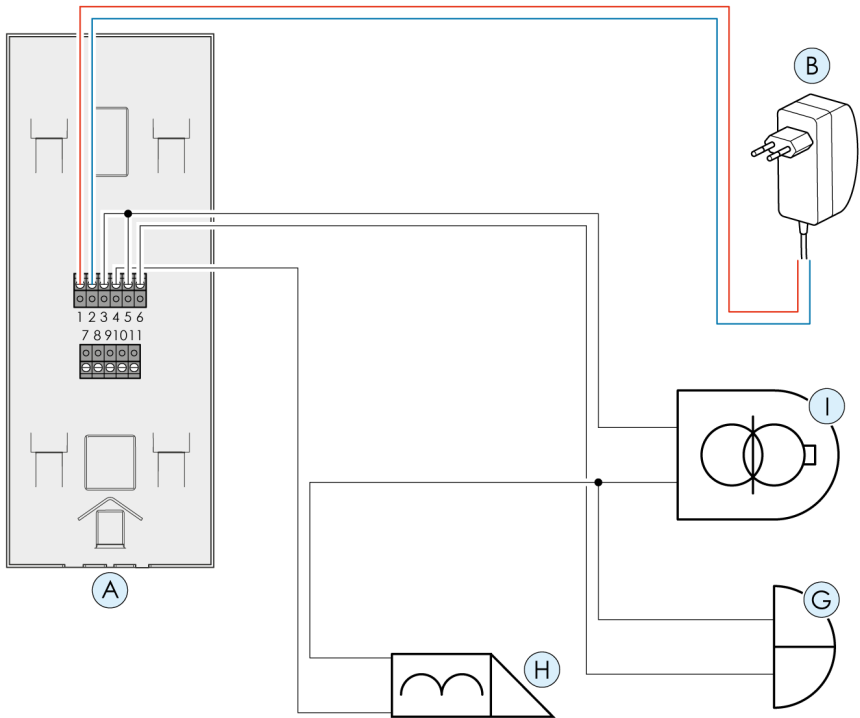

Item	Description
A	DoorLine (rear side)
B	Wall power supply
G	Door bell to relay contact 1
H	Door opener to relay contact 2
I	Bell transformer

4.6.6 DoorLine registration

Note: The DoorLine permits registration to a PBX system only during the first 15 minutes after application of the power supply. Readiness for registration can be activated again for 15 minutes at any time by briefly interrupting the voltage supply.

The DECT-PIN of the DoorLine cannot be changed and is permanently set to 0000. If a different DECT PIN is configured on your PBX system, it must be changed prior to registration to 0000.

Important: The DECT-PIN is not the PIN code for configuration of the DoorLine Slim DECT.

Further information on changing the DECT-PIN is available in the Operating Instructions of your PBX system.



The DoorLine remains for up to 2 minutes in registration mode. If you have to cover a long distance to reach your PBX system, first change the DoorLine to registration mode. The time required can vary according to the PBX system.

1. Apply the voltage supply.
 - ⇒ The DoorLine starts up. If the surrounding area is dark, the DoorLine lighting switches on.
2. Switch your PBX system to registration mode.
3. Actuate both bell pushbuttons for 5 seconds.
 - ⇒ Press both buttons at the same time because otherwise normal ringing of the bell will be detected.
 - ⇒ When the button is pressed, a double acknowledgement tone sounds immediately.
 - ⇒ After 5 seconds, a single acknowledgement tone sounds. The buttons can now be released. The DoorLine registers at the base which is now ready for registration.
4. After successful registration, a double acknowledgement tone sounds.
 - ⇒ Your PBX system assigns a new internal call number for the DoorLine. The DoorLine can now be reached and can call under this call number.
 - ⇒ If registration is unsuccessful, a negative acknowledgement tone sounds (eight short beeps in succession). Registration could not be carried out successfully and has to be restarted.

- ⇒ In the case of a restart of the DoorLine, it checks into the previously registered PBX system automatically. After every successful check-in, a double acknowledgement tone sounds.

4.6.7 Checking connection

Note: Due to the registration via DECT, the DoorLine is treated by your PBX system like a conventional wireless telephone.

If you receive a call from outside, all telephones that were assigned to this external number ring. Depending on the PBX system, after initial registration the DoorLine will probably be assigned automatically to an external number, i.e. all calls are also forwarded to the DoorLine. After the first bell signal, the DoorLine automatically receives all calls. The caller would thus be connected to the DoorLine.

A remedy in such a case can be provided by reconfiguring your PBX system. It has to be set such that the DoorLine does not react to external calls

1. Call the DoorLine from a telephone that is connected to your PBX system (see chapter Calling the DoorLine [► 50])
 - ⇒ A double tone sounds in the telephone. The voice communication between telephone and DoorLine is then built up.
 - ⇒ If the device does not react, disconnect it immediately from the power-supply system. Now check the connection of terminals 1 and 2 to the wall power supply for a wiring fault (e.g. reverse polarity of line).
2. After registration of the DoorLine, check the configuration of your PBX system. The PBX system is treated like a conventional wireless telephone. It has to be set such that the DoorLine does not react to external calls.

4.6.8 Check of DECT signal strength

After the voltage supply is applied, the background lighting flashes for the first 60 seconds to indicating the DECT signal strength.

Meaning of the flashing signals:

3-fold flashing	Strong signal
2-fold flashing	Medium signal
1-fold flashing	Weak signal
Continuous flashing	No connection to the PBX system or not registered
No flashing	Signal present but too weak for reliable operation

Continuous flashing is always displayed in addition if the DoorLine has not connection to the PBX system.

4.7 Labelling bell pushbuttons

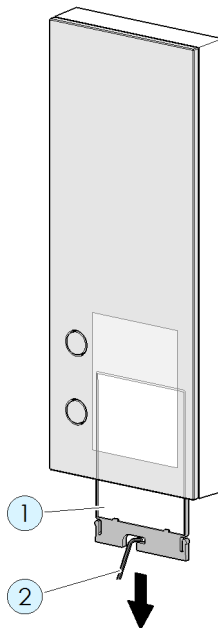

4

Assembly and connection

1. Pull down the drawer (1) with the help of the enclosed Allen key (2) to remove it.
2. Remove the paper.
3. Label the paper as desired.
4. Place the paper in the drawer.
5. Push the drawer to close it.

Insertion label blank

Paper size: 50x69.5 mm

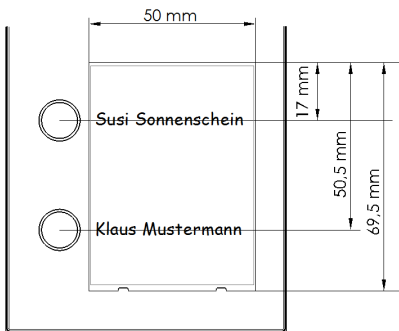

You can find our **Label Assistant** on our home page under the Product description of the device. It helps you with simple and professional labelling of the insertion label.





5 Configuration

5.1 Factory settings

The following parameters are preset ex works:

PIN Code	0000
Door opener function	Blocked
Door opener time	3 seconds
Call duration	1 minute
Door call duration	30 seconds
Call number, bell pushbutton 1	**91
Call number, bell pushbutton 2	**92
Call reception	Mute connection setup
Configuration of relay contact 1	External gong for all bell pushbuttons
Configuration of relay contact 2	Door opener
SwitchBox	None

5.2 Restoring factory settings



1.		Enter the configuration mode (see chapter Entry to configuration mode [► 26])
2.	 	Actuate the hashtag button and star button on the telephone
3.	 	Enter configuration command "99" at the telephone
		A melody rings out. After approx. 3 seconds you hear the positive acknowledgement tone. The device is now in delivery status.

Note: When restoring the factory settings of the DoorLine, the registered PBX system is not deleted!

5.3 Acknowledgement tones

During programming, you will be informed about the positive and negative acknowledgement tones via the programming status.

Each note symbol corresponds to a beep:

neutral	Key input is expected	
positive	The programming has been accepted	
negative	The programming has not been accepted	

5.4 Saving and ending configuration

To end the configuration, it is sufficient to hang up the telephone receiver. The device then detects the end of the call automatically and saves the changed configuration.







5.5 Entry to configuration mode

For configuration, you have to call your DoorLine with a touch-tone dialling telephone. The way you can call the DoorLine depends on the configuration of your PBX system.

When the connection to the device has been established, you can start with the configuration.

Notes

- Write down the corresponding codes for your own reference before you start the configuration.
- In programming mode, the call duration is unlimited.
- If the programming is rejected by the device (negative acknowledgement tone), you will have to repeat the incorrect programming step.
- If you entered the wrong PIN three times in succession, the connection is disconnected.

1		Pick up the receiver
2		Call the device
		You will hear the positive acknowledgement tone
3		Actuate the hashtag button twice on the telephone
		You will hear the neutral acknowledgement tone
4		Enter the PIN
		You will hear the positive acknowledgement and are now in programming mode

If you hear the positive acknowledgement tone, you can start with the programming. Otherwise the procedure must be repeated.

If you are in programming mode, you can carry out all configuration options one after the other.

5.6 Defining microphone sensitivity and volume







The microphone sensitivity and volume of the loudspeaker can be set in 10 stages. When the maximum or minimum possible value is reached, you will hear a positive acknowledgement tone. Each correct key input is confirmed by a neutral acknowledgement tone.

The following code numbers are possible:

- ② Code number 2 reduces the microphone sensitivity
- ③ Code number 3 increases the microphone sensitivity
- ⑤ Code number 5 reduces the loudspeaker sensitivity
- ⑥ Code number 6 increases the loudspeaker sensitivity

5.7 Change the PIN Code

In delivery status, the PIN Code for the configuration is "0000". To prevent the settings of your DoorLine from being changed by unauthorised persons, you should change the PIN Code as follows:

1.		Enter the configuration mode (see chapter Entry to configuration mode [▶ 26])
2.		Actuate the hashtag button and star button on the telephone
3.		Enter configuration command "88" at the telephone
		You will hear the neutral acknowledgement tone
4.		Enter new 4-digit PIN Code
		You will hear the neutral acknowledgement tone
5.		Repeat new PIN Code
		You will hear the positive acknowledgement tone



If changing of the PIN Code is not completed with the positive acknowledgement tone, check whether the correct PIN Code was input when you entered the configuration mode. This is not checked by the DoorLine until the end of the complete procedure.



Changes to the configuration are only possible with knowledge of your PIN Code. For security reasons, enter your new PIN Code in the configuration table (see Overview of configuration commands [▶ 45]).







5.8 Call numbers for bell pushbuttons

Each bell pushbutton can be assigned 2 call numbers.













The second call number serves as an alternative number. This number is dialled if the call to the first number is not answered or the call destination is currently busy.

5.8.1 Defining call numbers for bell pushbuttons

Configuration example: Call number 1 for bell pushbutton 1:

1.		Enter the configuration mode (see chapter Entry to configuration mode [► 26])
2.	 	Actuate the hashtag button and star button on the telephone
3.	 	Enter configuration command for call number bell pushbutton 1 "11" at the telephone
4.		Neutral acknowledgement tone
5.		Enter call number (max. 20-digit) that is to be assigned to the bell pushbutton
		If no input is made for 5 seconds, you will hear the positive acknowledgement tone and the call number will be saved

The remaining call numbers are configured in the same manner. The following commands must be used to do this:

   	Configuration of call number 2 for bell pushbutton 1
   	Configuration of call number 1 for bell pushbutton 2
   	Configuration of call number 2 for bell pushbutton 2

5.8.2 Deleting call numbers

You can delete a call number that is saved on a button.

Configuration example: Deleting call number 1 for bell pushbutton 1:









1.		Enter the configuration mode (see chapter Entry to configuration mode [► 26])
2.	# *	Actuate the hashtag button and star button on the telephone
3.	1 1	Enter configuration command for call number bell pushbutton 1 "11" at the telephone
4.	♪	Neutral acknowledgement tone
5.	♪♪	If no input is made for 5 seconds, you will hear the positive acknowledgement tone and the call number will be deleted

The remaining call numbers are deleted in the same manner. The following commands must be used to do this:

# * 1 2	Deletion of call number 2 for bell pushbutton 1
# * 2 1	Deletion of call number 1 for bell pushbutton 2
# * 2 2	Deletion of call number 2 for bell pushbutton 2

5.9 Enabling door opener function

For security reasons to prevent unauthorised opening, the door cannot be opened if the connection was set up from the telephone to the door intercom. This function can be deactivated if desired.

1.		Enter the configuration mode (see chapter Entry to configuration mode [▶ 26])
2.	 	Actuate the hashtag button and star button on the telephone
3.	 	Enter configuration command "04" at the telephone
		As confirmation, you will hear a neutral acknowledgement tone
4.		Enter digit 1 to enable the door opener function or
		digit 0 to block the door opener function
		Finally, you will hear the positive acknowledgement tone

5.10 Defining door opener time

Actuation time of the door opener.

Possible values: 1 to 9 seconds or deactivate with 0







Delivery status: 3 seconds

With door opening with redial #9

If relay contact 2 was defined as door opener

or

if a contact of a SwitchBox was defined as door opener with redial #9.







1.		Enter the configuration mode (see Entry to configuration mode [▶ 26])
2.	 	Actuate the hashtag button and star button on the telephone
3.	 	Enter configuration command "05" at the telephone
		As confirmation, you will hear a neutral acknowledgement tone
4.		Define the switching time of the door opener by entering the digits 1 to 9 (digit corresponds to the duration in seconds, 0=deactivated)
		Finally, you will hear the positive acknowledgement tone

With door opening with redial #8

If relay contact 1 was defined as door opener

or

if a contact of a SwitchBox was defined as door opener with redial #8.

1.		Enter the configuration mode (see Entry to configuration mode [▶ 26])
2.	 	Actuate the hashtag button and star button on the telephone
3.	 	Enter configuration command "03" at the telephone
		As confirmation, you will hear a neutral acknowledgement tone
4.		Define the switching time of the door opener by entering the digits 1 to 9 (digit corresponds to the duration in seconds, 0=deactivated)
		Finally, you will hear the positive acknowledgement tone







5.11 Defining call duration

Definition of the call duration for the DoorLine.

When this time has elapsed, the door conversation is disconnected automatically.

Delivery status: one minute

Possible values: 1 to 9 minutes in steps of 1 minute or 0 for "without limitation".







1.		Enter the configuration mode (see Entry to configuration mode [► 26])
2.	 	Actuate the hashtag button and star button on the telephone
3.	 	Enter configuration command "07" at the telephone
		As confirmation, you will hear a neutral acknowledgement tone
4.		Define the call duration by entering the digits 1 to 9 (digit corresponds to the duration in minutes, 0=without limitation)
		Finally, you will hear the positive acknowledgement tone

5.12 Defining call duration to extension line

Definition of the duration of the door call to the extension line of your PBX system.

Delivery status: 30 seconds

Possible values: 1 to 99 seconds.





1.		Enter the configuration mode (see Entry to configuration mode [▶ 26])
2.	 	Actuate the hashtag button and star button on the telephone
3.	 	Enter configuration command "08" at the telephone
		As confirmation, you will hear a neutral acknowledgement tone
4.		Enter call duration with digits 01, ... 99 (in steps of one second). The input must have two digits
		Finally, you will hear the positive acknowledgement tone

5.13 Call mode

Call mode determines the way the DoorLine Slim DECT sets up a call to the remote station.





5.13.1 Mute connection setup with call reception by button redial

The loudspeaker of the DoorLine is switched to mute during the complete call setup. The voice connection between DoorLine and telephone is not established until the receiver of the called telephone is picked up and a random digit key has been pressed on the telephone.

1.		Enter the configuration mode (see chapter Entry to configuration mode [▶ 26])
2.	 	Actuate the hashtag button and star button on the telephone
3.	 	Enter configuration command "70" at the telephone
		You will hear the positive acknowledgement tone





5.13.2 Connection setup with tone output

The loudspeaker is activated immediately, i.e. the call setup is completely audible at the DoorLine. The visitor can therefore also recognise whether the call setup is still ongoing or whether the call/conversation duration has already elapsed.

1.		Enter the configuration mode (see chapter Entry to configuration mode [▶ 26])
2.	 	Actuate the hashtag button and star button on the telephone
3.	 	Enter configuration command "71" at the telephone
		You will hear the positive acknowledgement tone

5.13.3 Mute connection setup

When the bell pushbutton has been pressed, only a short acoustic feedback signal is issued at the door voice station; no further tone is issued at the loudspeaker until the call reception is detected (factory setting). The switch-over to voice mode takes place automatically.

1.		Enter the configuration mode (see chapter Entry to configuration mode [▶ 26])
2.	 	Actuate the hashtag button and star button on the telephone
3.	 	Enter configuration command "72" at the telephone
		You will hear the positive acknowledgement tone

5.14 Defining absence numbers

Two call numbers can be saved to which door calls can be redirected as required.

The second call number is an alternative number which is dialled if the call to the first number is not answered or the call destination is currently busy.







Call forwarding to these call numbers can be activated/deactivated for each bell pushbutton as required (see chapter Activating / deactivating call forwarding to absence number [► 51]).

Precondition for call forwarding to an external destination





The extension line on which the DoorLine is registered must have an authorisation for receiving external telephone calls.

In most telephone systems this function is referred to as "direct outward dialling".

5.14.1 Defining call numbers for call forwarding

1.		Enter the configuration mode (see chapter Entry to configuration mode [► 26])
2.		Actuate the hashtag button and star button on the telephone
3.		Input of the first call number: enter configuration command "51" at the telephone or
		Input of the alternative number: enter configuration command "52" at the telephone
4.		Neutral acknowledgement tone
5.		Enter target call number (max. 20 digits).
		If no input is made for 5 seconds, you will hear the positive acknowledgement tone and the call number will be saved

5.14.2 Deleting call numbers for call forwarding

1.		Enter the configuration mode (see chapter Entry to configuration mode [▶ 26])
2.		Actuate the hashtag button and star button on the telephone
3.		Delete the first call number: enter configuration command "51" at the telephone or
		Delete the alternative number: enter configuration command "52" at the telephone
4.		Neutral acknowledgement tone
5.		If no input is made for 5 seconds, you will hear the positive acknowledgement tone and the call number will be deleted

5.15 Configuring relay contacts





The two relay contacts can be used





- as a door opener or
- to activate a door gong.

Each contact can be assigned to one or both bell pushbuttons.

The relay contact is connected when a bell pushbutton is pressed. The contact remains connected as long as the bell pushbutton is pressed.

5.15.1 Configuration of relay contact 1

1.		Enter the configuration mode (see chapter Entry to configuration mode [▶ 26])
2.		Actuate the hashtag button and star button on the telephone
3.		Enter configuration command "61" at the telephone
		Neutral acknowledgement tone
4.		Enter switching command in accordance with the following table
		You will hear the positive acknowledgement tone as confirmation





Switching command	Bell push-button	Bell push-button	Redial	Comments
	1	2	#8	
0	-	-		Relay contact 1 connects with redial of #8 during voice communication.
1		-	-	
2	-		-	
3			-	Factory setting.





Example: You wish to assign relay contact 1 to bell pushbutton 2 to actuate a door gong. After entry to the configuration mode, enter the following in the configuration for this purpose:

#*61 ⇒ wait for neutral tone ⇒ 2 ⇒ positive acknowledgement tone sounds.

5.15.2 Configuration of relay contact 2

Configuration of relay contact 2



1.		Enter the configuration mode (see chapter Entry to configuration mode [▶ 26])
2.		Actuate the hashtag button and star button on the telephone
3.		Enter configuration command "62" at the telephone
		Neutral acknowledgement tone
4.		Enter switching command in accordance with the following table
		You will hear the positive acknowledgement tone as confirmation

Switching command	Bell push-button	Bell push-button	Redial	Comments
	1	2	#9	
0	-	-		Relay contact 2 connects with redial of #9 during voice communication. Factory setting.
1		-	-	
2	-		-	
3			-	

6 Configuration of SwitchBox

A SwitchBox SB-442 can be connected to the DoorLine. The SwitchBox SB-442 provides three additional configurable relay contacts.











6.1 Registering SwitchBox

1.		Enter the configuration mode (see Entry to configuration mode [▶ 26])
2.	#*	Actuate the hashtag button and star button on the telephone
3.	01	Enter configuration command "01" at the telephone
		As confirmation, you will hear a neutral acknowledgement tone
4.	1	Enter digit 1 to register the SwitchBox SB-442 or Enter digit 0 if no SwitchBox is to be used
		Finally, you will hear the positive acknowledgement tone

6.2 Defining PIN Code for SwitchBox

For security reasons, communication between the DoorLine and the SwitchBox is protected by a PIN Code. In delivery status, the PIN Code for the SwitchBox is "0000". In order to use the SwitchBox, this PIN Code must be changed. The PIN Code must be between 4 and 12 characters long and must only contain numeric characters.

1.		Enter the configuration mode (see Entry to configuration mode [▶ 26])
2.	#*	Actuate the hashtag button and star button on the telephone
3.	02	Enter configuration command "02" at the telephone
		As confirmation, you will hear a neutral acknowledgement tone

4.		Enter the previous PIN Code (factory setting "0000")
5.		Actuate the hashtag button on the telephone
		You will hear the neutral acknowledgement tone
6.		Enter the new PIN Code ("0000" will not be accepted)
7.		Actuate the hashtag button on the telephone
		You will hear the neutral acknowledgement tone
8.		Enter the new PIN Code
9.		Actuate the hashtag button on the telephone
		If the new PIN Code was saved in the SwitchBox, you will hear the positive acknowledgement tone. This can take a few seconds or
		If an error occurred, you will hear the negative acknowledgement tone (8 short beeps). After the third unsuccessful attempt, the connection is disconnected. The procedure must be repeated starting at point 1



A PIN Code for the SwitchBox can only be entered if the SwitchBox was previously registered (see Registering SwitchBox [▶ 40]).

6.3 Configuring SwitchBox relay contacts







The three relay contacts can be used







- as a door opener or
- to activate a door gong.

Each contact can be assigned to one or both bell pushbuttons.







The relay contact is connected when a bell pushbutton is pressed. The contact remains connected as long as the bell pushbutton is pressed.







6.3.1 Configuring SwitchBox relay contact 1

1.		Enter the configuration mode (see chapter Entry to configuration mode [► 26])
2.	 	Actuate the hashtag button and star button on the telephone
3.	 	Enter configuration command "63" at the telephone
		Neutral acknowledgement tone
4.		Enter switching command in accordance with the following table
		You will hear the positive acknowledgement tone as confirmation





Switching command	Bell push-button 1	Bell push-button 2	Redial	Comments
	1	2	#8/9	
0	-	-		Relay contact 1 connects with redial of #9 during voice communication. Factory setting.
1		-	-	
2	-		-	
3			-	
4	-	-		Relay contact 1 connects with redial of #8 during voice communication.







6.3.2 Configuring SwitchBox relay contact 2

1.		Enter the configuration mode (see chapter Entry to configuration mode [► 26])
2.	 	Actuate the hashtag button and star button on the telephone
3.	 	Enter configuration command "64" at the telephone
		Neutral acknowledgement tone
4.		Enter switching command in accordance with the following table
		You will hear the positive acknowledgement tone as confirmation

Switching command	Bell push-button	Bell push-button	Redial	Comments
	1	2	#8/9	
0	-	-		Relay contact 2 connects with redial of #9 during voice communication.
1		-	-	Factory setting.
2	-		-	
3			-	
4	-	-		Relay contact 2 connects with redial of #8 during voice communication.

6.3.3 Configuring SwitchBox relay contact 3

1.		Enter the configuration mode (see chapter Entry to configuration mode [► 26])
2.		Actuate the hashtag button and star button on the telephone
3.		Enter configuration command "65" at the telephone
		Neutral acknowledgement tone
4.		Enter switching command in accordance with the following table
		You will hear the positive acknowledgement tone as confirmation

Switching command	Bell push-button	Bell push-button	Redial	Comments
	1	2	#8/9	
0	-	-		Relay contact 3 connects with redial of #9 during voice communication.
1		-	-	
2	-		-	Factory setting.
3			-	
4	-	-		Relay contact 3 connects with redial of #8 during voice communication.

7 Overview of programming table

The following table contains an overview of all programming commands. In order to use the programming commands, registration by means of the PIN Code in configuration mode is required (see chapter Entry to configuration mode [► 26]).

Programming command	Own settings	Description
##<PIN Code>		Entry to the configuration. Factory setting of PIN Code: 0000
#*01 <SwitchBox>		SwitchBox: 0=no SwitchBox 1=use SwitchBox
#*02 <PIN old>#<PIN new>#<PIN new>#		Change PIN Code for Switch-Box
#*04 <Door opener function>		Door opener function: 0=disabled 1=enabled Factory setting: disabled
#*05 <Door opener time>		Switching time for door opener: 1 to 9 seconds or 0 (door opening not possible) Factory setting: 3 seconds
#*07 <Call duration>		Defining maximum call duration: 1 -9 minutes or 0=without limitation Factory setting: 1 minute
#*08 <Call duration>		Call duration to extension line: 01-99 seconds (double-digit entry) Factory setting: 30 seconds
#*11 <Call number>		Call number to be called from bell pushbutton 1
#*12 <Call number>		Alternative number to be called from bell pushbutton 1

Programming command	Own settings	Description
#*21 <Call number>		Call number to be called from bell pushbutton 2
#*22 <Call number>		Alternative number to be called from bell pushbutton 2
#*51 <Call number>		Call number to be called during active call forwarding
#*52 <Call number>		Alternative number to be called during active call forwarding
#*61 <Command 0-3>		Configuration of relay contact 1. See Configuring relay contacts [▶ 37]
#*62 <Command 0-3>		Configuration of relay contact 2. See Configuring relay contacts [▶ 37]
#*63 <Command 0-4>		Configuration of SwitchBox relay contact 1. See Configuring SwitchBox relay contacts [▶ 41]
#*64 <Command 0-4>		Configuration of SwitchBox relay contact 2. See Configuring SwitchBox relay contacts [▶ 41]
#*65 <Command 0-4>		Configuration of SwitchBox relay contact 3. See Configuring SwitchBox relay contacts [▶ 41]
#*70		Call reception by pushbutton (factory setting)
#*71		Call reception by direct operation
#*72		Definition of call mode
#*88 <PIN><PIN>		Enter new PIN Code twice

Programming command	Own settings	Description
#*99		Reset to factory setting
2		Reduce microphone sensitivity
3		Increase microphone sensitivity
5		Reduce loudspeaker volume
6		Increase loudspeaker volume

Ending programming







Hang up the receiver
or enter #0.

8 Everyday use







8.1 Receiving a door call

A bell pushbutton is pressed at the DoorLine.
The saved call number is called.
The telephone of the called connection rings.



With call mode "Mute connection setup" and "Connection setup with tone output"

1.		Pick up telephone.
		Voice communication is established directly
2.		Hang up the receiver to end the voice communication or
		enter digits #0 (disconnects the connection immediately) or
		the maximum call duration is reached. The connection is then disconnected automatically

With call mode "Mute connection setup with call reception by button redial"

1.		Pick up telephone. An attention tone (beep) indicates a call from the DoorLine
		Actuate a random numeric key
		Voice communication is established directly
2.		Simply hang up the receiver to end the voice communication or
		enter digits #0 (disconnects the connection immediately) or
		the maximum call duration is reached. The connection is then disconnected automatically

8.2 Opening a door

1.		A door call takes place
2.		enter button command #8 (if relay contact 1 is set as door opener) or
		Enter button command #9 (if relay contact 2 is set as door opener)
		The door opener is activated





Important:

- In delivery status of the DoorLine, the door cannot be opened from the telephone during a call setup. If this security measure is not required, it can be cancelled by a corresponding configuration (see chapter Enabling door opener function [▶ 31]).
- The time duration for the electric door opener can be set from 1-9 seconds (see chapter Defining door opener time [▶ 31]).



8.3 Calling the DoorLine

The DoorLine can also be called directly.

Setting up connection

1.		Pick up telephone
2.		Enter the call number of your DoorLine
		You will hear the positive acknowledgement tone
		Voice communication is established directly

Ending connection

1.		Simply hang up the receiver to end the voice communication or
		enter digits #0 (disconnects the connection immediately) or
		the maximum call duration is reached. The connection is then disconnected automatically

8.4 Activating / deactivating call forwarding to absence number









Example:

You leave the house and are expecting a parcel service or important visitor. When you leave your house, you can now simply forward the door call to your mobile telephone or another telephone.









Prerequisites:

The call numbers for call forwarding must be defined in advance (see chapter Defining absence numbers [► 36]).

Activating call forwarding

1.		Pick up telephone
2.		Call the DoorLine
		You will hear the positive acknowledgement tone
3.		Press the hashtag button
4.		Enter digit (1-2) for the relevant bell pushbutton
5.		Enter digit 1 for activation
		You will hear the positive acknowledgement tone. Forwarding is active
6.		Hang up the receiver

Deactivating call forwarding

1.		Pick up telephone
2.		Call the DoorLine
		You will hear the positive acknowledgement tone
3.		Press the hashtag button
4.		Enter digit (1-2) for the relevant bell pushbutton
5.		Enter digit 0 for deactivation
		You will hear the positive acknowledgement tone. Forwarding is deactivated
6.		Hang up the receiver

8.5 Direct commands during voice communication

During a door call, you have the following additional input options on your telephone:

# 0	Disconnects the connection immediately. DoorLine moves to standby
# 1 0	Deactivates call forwarding to absence numbers button 1
# 1 1	Activates call forwarding to absence numbers button 1
# 2 0	Deactivates call forwarding to absence numbers button 2
# 2 1	Activates call forwarding to absence numbers button 2
# 8 or # 9	<p>Activates the door opener</p> <p>Function is only available if</p> <ul style="list-style-type: none"> ▪ a relay contact is configured as door opener and <ul style="list-style-type: none"> – the door call was set up by the DoorLine or – the door opener function was enabled in the configuration of the DoorLine

Important:

The contacts can only be switched via these direct commands if they have been assigned the function "Redial" in the configuration.

9 Malfunctions and fault elimination

The following table contains the most frequently occurring malfunctions and their correction. In case of other malfunctions, please contact specialist dealer or our technical Hotline (see rear side of device).

Malfunction	Reason	Solution
No function	No operating voltage	Check installation. Check Connections at the terminals for correct connection order.
	Rapid continuous flashing of the button lamp	DoorLine is not registered in the telephone system. Register DoorLine in accordance with chapter DoorLine registration [► 21] in the telephone system.
	Rapid continuous flashing of the button lamp	DoorLine has no DECT reception.
Incorrect bell signalling No dialling	Incorrect programming of the call numbers for the bell pushbuttons	Check programming of buttons, repeat if necessary
Poor, intermittent or interrupted voice communication	The DECT reception at the position of the DoorLine is inadequate.	Provide a better DECT reception in the area of the DoorLine. If necessary, use repeaters from the respective manufacturer to extend the transmission range of the PBX system.

10 Maintenance, care and disposal

10.1 Cleaning

Caution: Unsuitable cleaning agents can damage the surface of the device. Clean the device with a soft, slightly damp cloth. Never use hard objects or scouring or aggressive cleaning agents.

10.2 Storage

If the device is not installed, store it in a condensate-free area at an ambient temperature of -20 °C to +60 °C.

10.3 Disassembly

Prior to disassembly of the device, de-energise all components used.

Proceed in reverse sequence to assembly (see Installing device on mounting plate [► 15]).

10.4 Disposal

10.4.1 Disposing of packaging material

All packaging materials are environmentally compatible and recyclable. The packaging material can be returned to the sales outlet or the local collection centres for used paper and plastic materials.

10.4.2 Disposing of old device



The product belongs to the category electrical and electronic equipment. In accordance with the EC Directive 2012/96/EC, it must not be disposed of together with household waste but must be delivered to the local return system for electrical and electronic equipment.









Technical Hotline

If you have questions on the operation or configuration of your DoorLine that cannot be answered in these Operating Instructions, please contact your specialist dealer.

If your specialist dealer cannot help, our Hotline is at your disposal.

Usage of the Hotline incurs the normal connection costs.

Telegärtner Elektronik Hotline

Tel.:	+49 7951 488 9200
Monday-Thursday:	7:00 - 16:30 hours
Friday:	7:00 - 13:00 hours
service@telegaertner-elektronik.de	

Issued by / Manufacturer:

Telegärtner Elektronik GmbH
Hofäckerstraße 18
D-74564 Crailsheim
+49 7951 4880

www.telegaertner-elektronik.de
info@telegaertner-elektronik.de



Version:

2.0 / 2020/02/27
EN-Translation of the Original Operating
and Assembly Instructions
Item No.: 116332